

LSST



Andreas Korn,
University College London

Andreas.Korn@cern.ch

Introduction

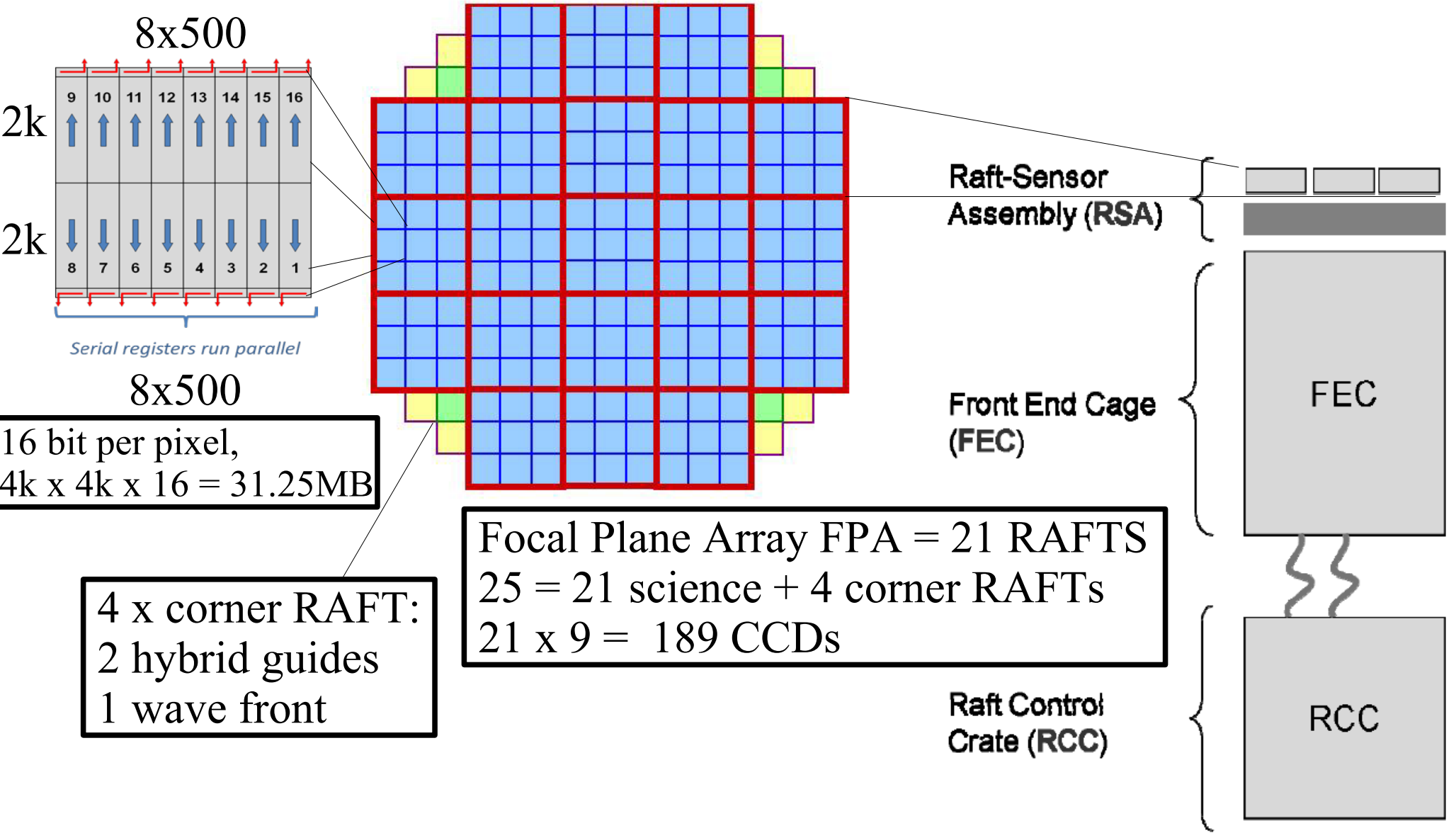
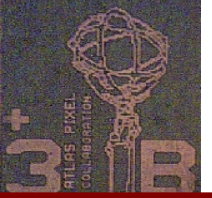



Introduction

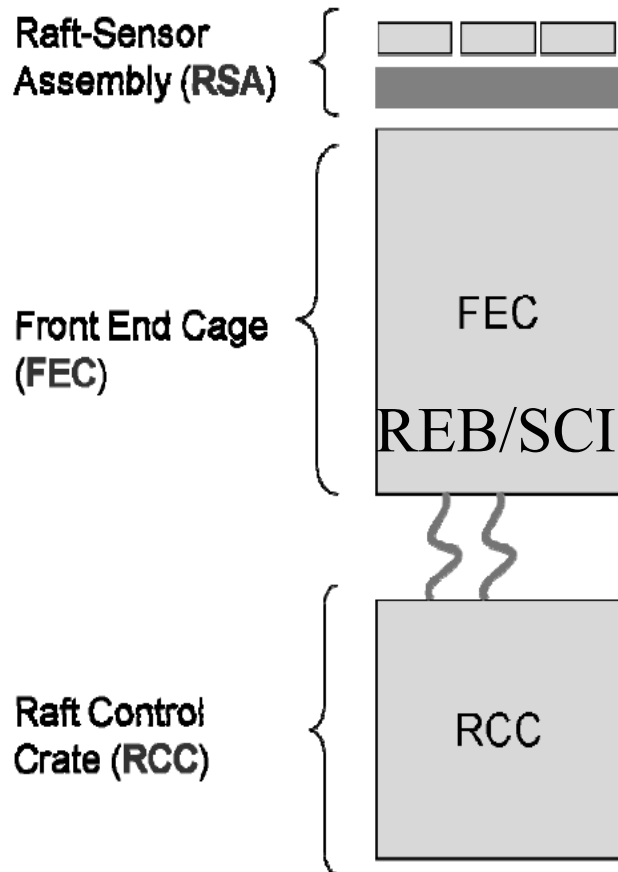

$$21 \times 3 + 4 \times 2 = 71 \text{ REB/SCI}$$

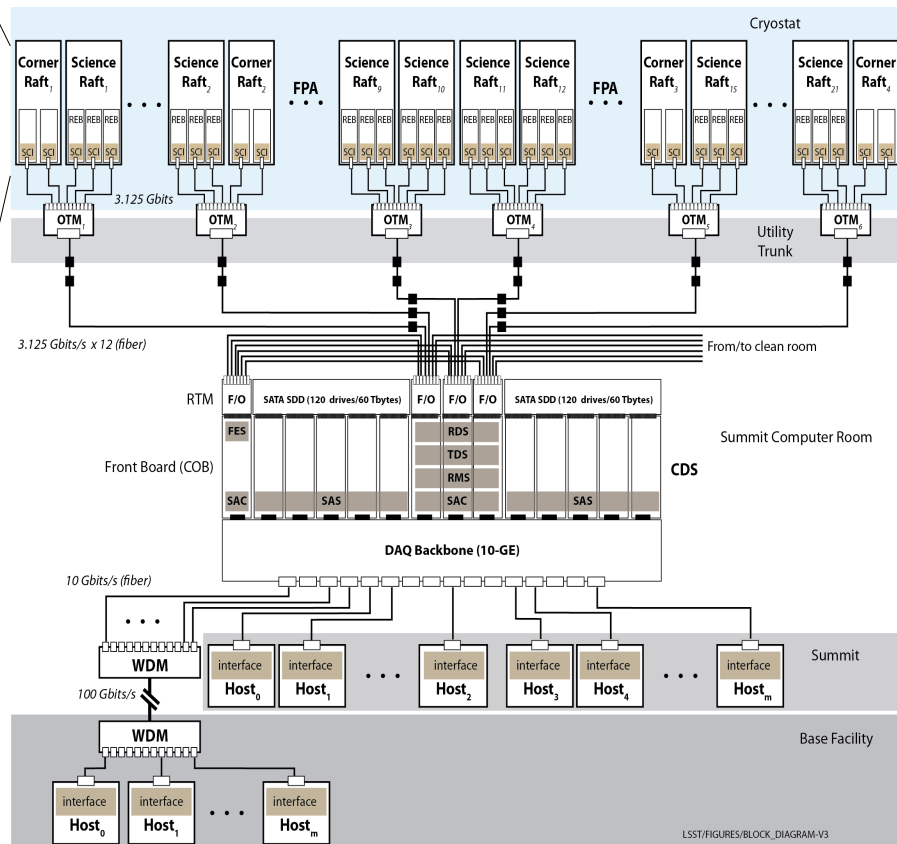

14 COBS:

- 3 service FPA
- 1 data emulation
- 10 data storage

12 SCI per OTM



Introduction

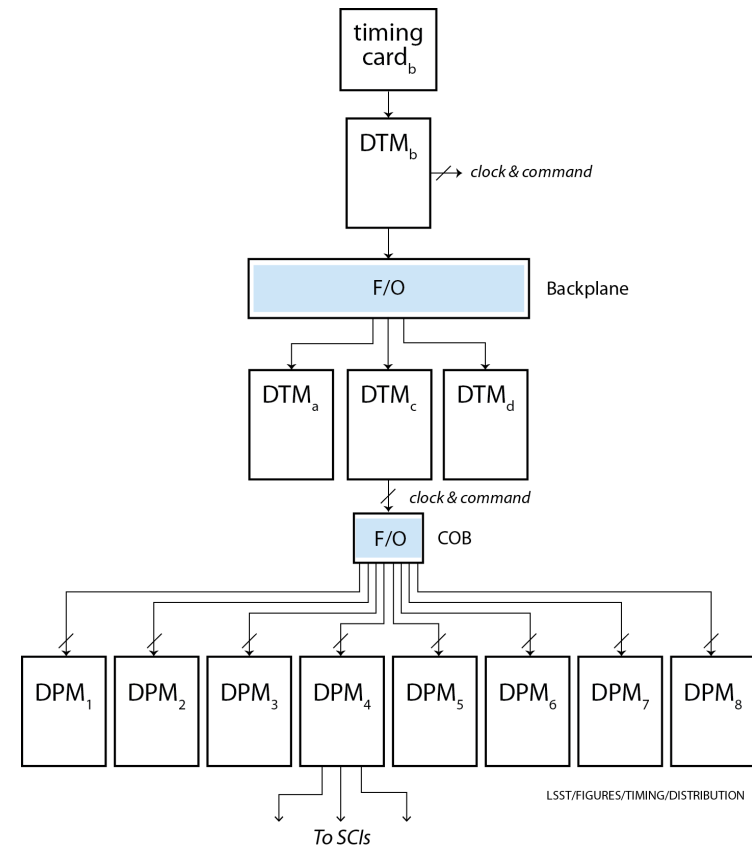
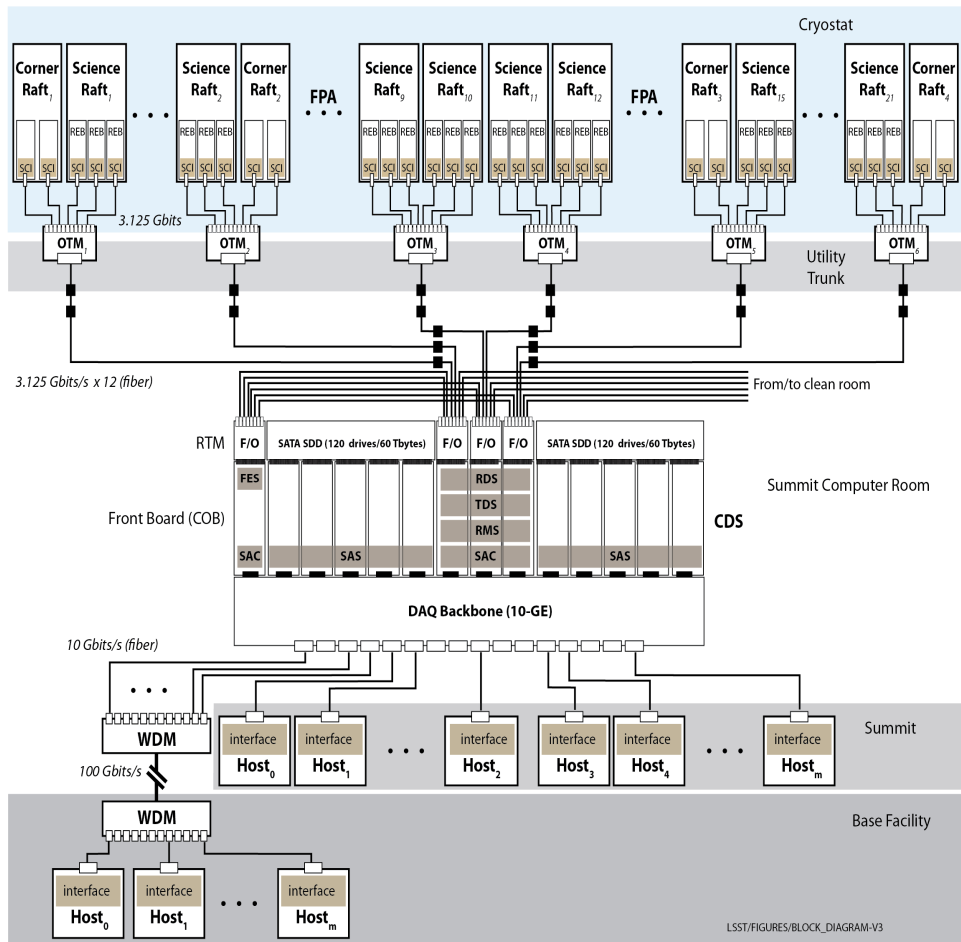

Storage Array Client SAC Storage Array Server SAS FrontEnd Emulation Server FES
 Raft Data Server RDS Raft Management Server RMS

Introduction

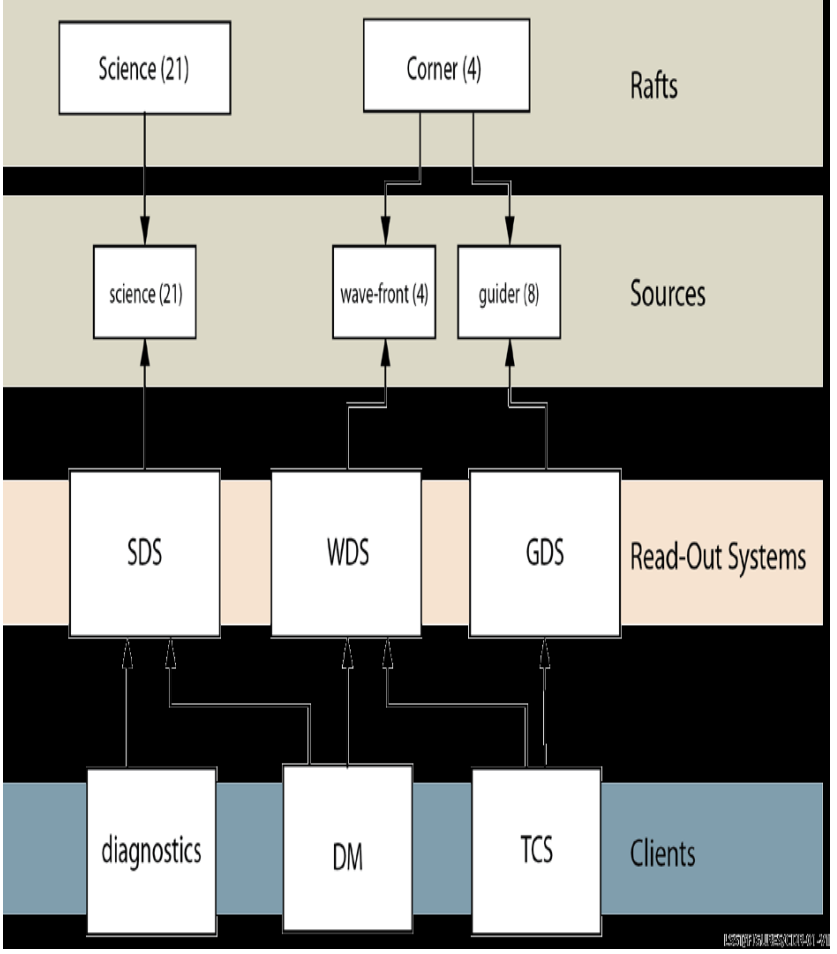
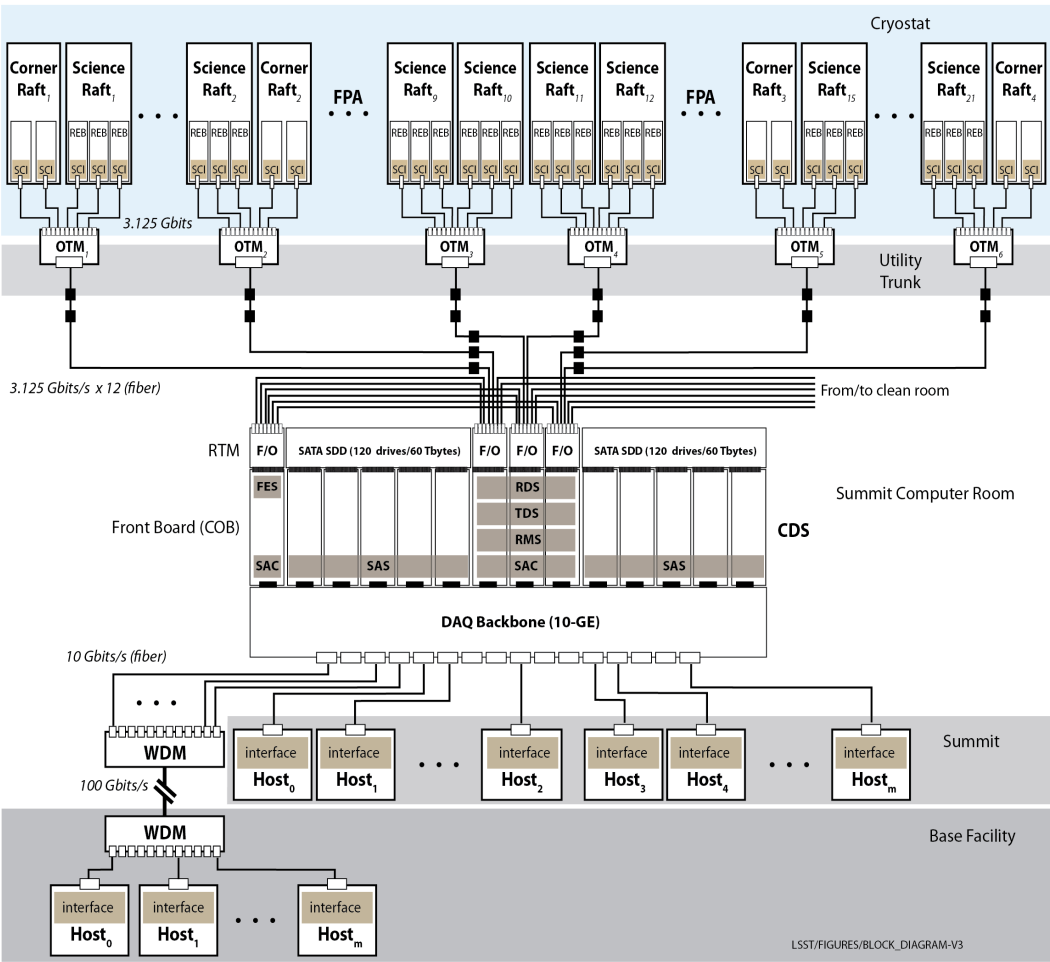

Camera Data System CDS Source Communication Interface SCI Science Data System SDS
 Wave-Front Data System WDS Guider Data System GDS Timing Distribution system TDS
 Telescope Control System TCS Camera Storage Service CSS

Bonus Slides